

### Jetter AG

Gräterstraße 2  
D-71642 Ludwigsburg  
Germany

### Kontakte:

E-Mail - Vertrieb: sales@jetter.de  
E-Mail - Hotline: hotline@jetter.de  
Telefon - Hotline: +49(0)7141/2550-444

## Installationsanleitung

Artikel-Nr.: 60873051 | Version 1.50

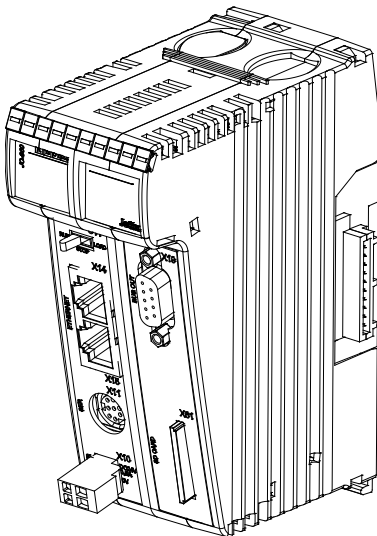

Dezember 2016 / Printed in Germany

Laden Sie die Betriebsanleitung von [www.jetter.de](http://www.jetter.de) unter Downloads herunter.

### Lieferumfang

1 x	JC-360	Optionen: [MC]-[A]-[R]
1 x	60870409	2-poliger Stecker, Zugfederanschluss
10 x	60870411	Klemmenmarkierer
1 x	60873051	Installationsanleitung

# Montage auf Hutschiene EN 50022

## Schritt

## Vorgehen

1

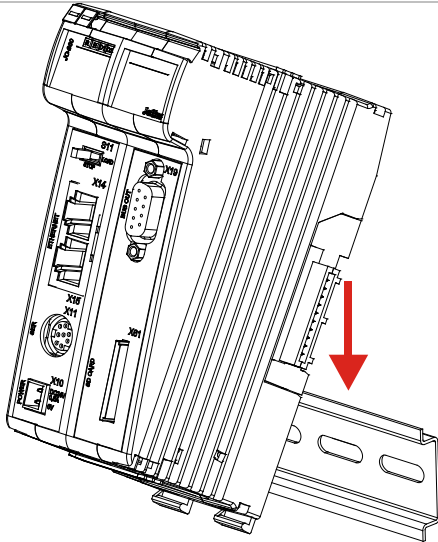

Setzen Sie die JC-360 auf die Hutschiene oben auf.

2

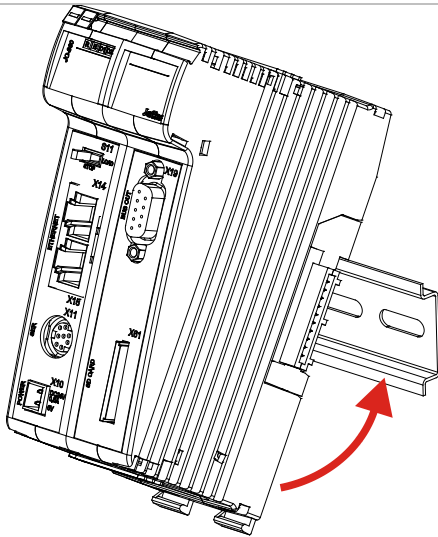

Bewegen Sie die JC-360 in Pfeilrichtung, bis sie auf der Hutschiene einrastet.

3

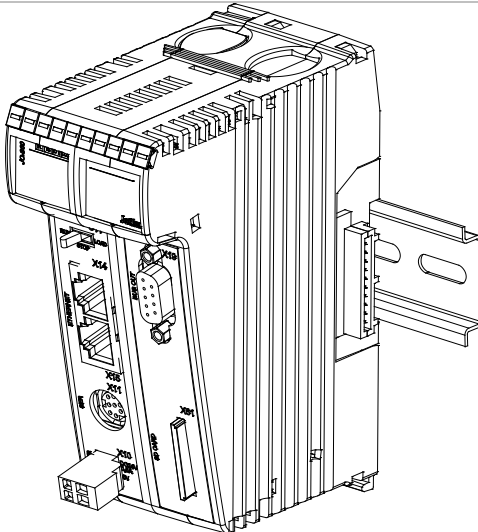

Die JC-360 sitzt nun fertig montiert auf der Hutschiene.

## Einstellen der IP-Adresse

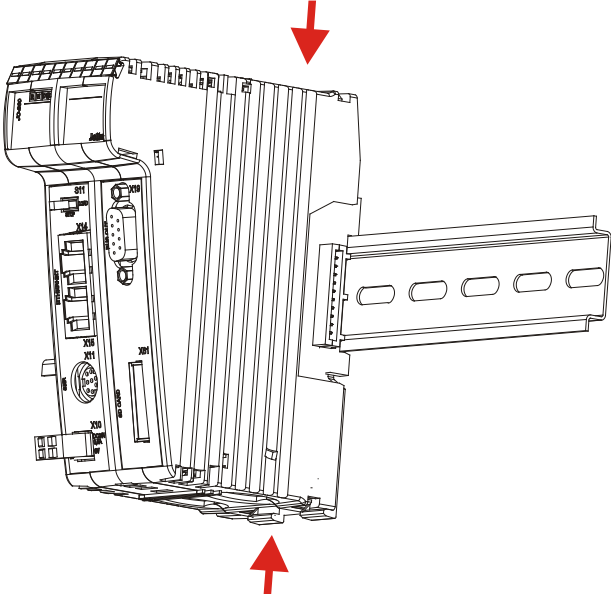
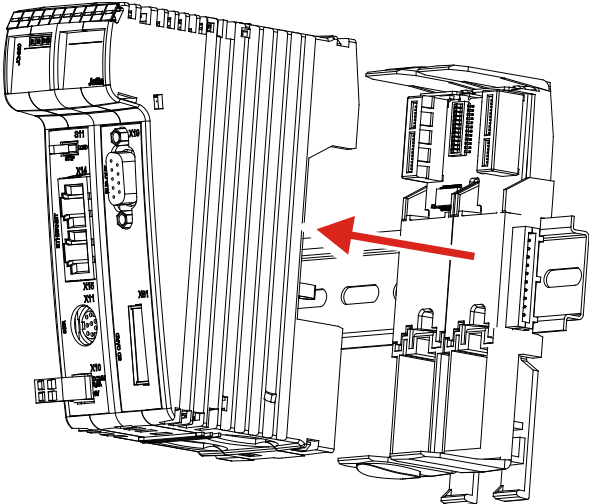
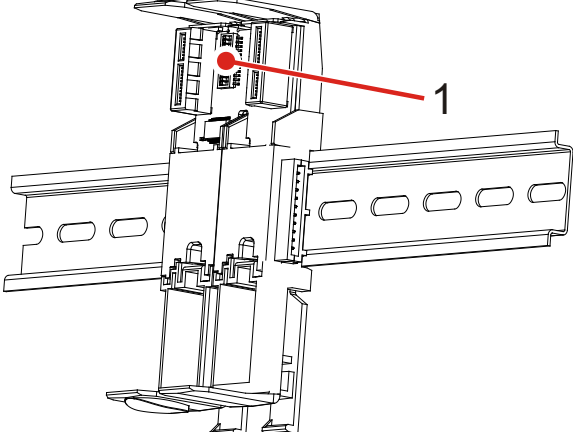
Schritt	Vorgehen
1	Schalten Sie die JC-360 und alle JX3-Module der JX3-Station spannungslos.
2	 <p>Drücken Sie auf die obere und untere Rastlasche.</p>
3	 <p>Ziehen Sie das JX3-Gehäuse nach vorne ab.</p>
4	 <p>Auf dem JX3-Backplane-Modul sind nun die DIP-Schalter (1) erreichbar.</p>

## Einstellen der IP-Adresse

























Schritt	Vorgehen
<b>5</b>	<p>Ändern Sie die IP-Adresse über die DIP-Schalter (1).</p> <div style="display: flex; justify-content: space-around; align-items: flex-start;"> <div style="text-align: center;"> <p>ON</p> <p>1 2 3 4 5 6 7 8 9 10 11 12</p> </div> <div style="text-align: left;"> <p>IP-Adresse: 192.168.1.1 Auslieferungszustand</p> </div> </div> <div style="display: flex; justify-content: space-around; align-items: flex-start; margin-top: 10px;"> <div style="text-align: center;"> <p>ON</p> <p>1 2 3 4 5 6 7 8 9 10 11 12</p> </div> <div style="text-align: left;"> <p>IP-Adresse: 192.168.10.15 Default IP-Adresse</p> </div> </div>
<b>6</b>	Setzen Sie das JX3-Gehäuse wieder auf das JX3-Backplane-Modul.
<b>7</b>	Versorgen Sie die JX3-Station wieder mit Spannung.

Weitere Informationen zum Einstellen der IP-Adresse entnehmen Sie der Betriebsanleitung.

## LEDs

	LED	Farbe	Beschreibung
	R	grün	Betriebssystem läuft
	E	rot	Allgemeiner Fehler
	D1	rot	Spezielle Zustände
	D2	rot	Bootloader läuft
	SD	gelb	Zugriff auf SD-Karte
	U1 ... U4	gelb	Anwendungsspezifisch programmierbar

## LED-Zustände beim Einschalten

Stufe	R	E	D1	D2	Beschreibung
<b>1</b>	 4Hz	 4Hz	 4Hz	 4Hz	Reset
<b>2</b>	 1Hz	 OFF	 OFF	 ON	Der Bootloader lädt und überprüft das Betriebssystem.
<b>3</b>	 1Hz	 OFF	 OFF	 OFF	Das Betriebssystem liest den DIP-Schalter auf dem JX3-Backplane-Modul und prüft das Vorhandensein des Ethernet-Switches.
<b>4</b>	 1Hz	 ON	 OFF	 OFF	Das Betriebssystem initialisiert Echtzeituhr, Ethernet-Schnittstelle und Dateisystem.
<b>5</b>	 1Hz	 ON	 ON	 OFF	Das Betriebssystem initialisiert die Module am JX3- und JX2-Systembus und die Software-Teile (Web, Modbus/TCP usw.); es lädt das Anwendungsprogramm.
<b>6</b>	 ON	 OFF	 OFF	 OFF	Normaler Betriebszustand

## Schalter S11

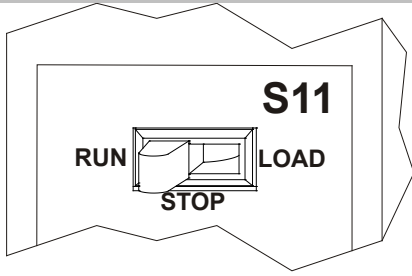

Stellung	Beschreibung
RUN	Steuerung JC-360 startet nach dem Einschalten das Anwendungsprogramm.
STOP	Steuerung JC-360 startet nicht das Anwendungsprogramm nach dem Einschalten.
LOAD	Steuerung JC-360 führt nach dem Einschalten die Datei <b>autocopy.ini</b> auf der SD-Karte aus. Ist keine SD-Karte vorhanden, startet der Bootloader das Betriebssystem nicht.

## Anschlussbeschreibung X10

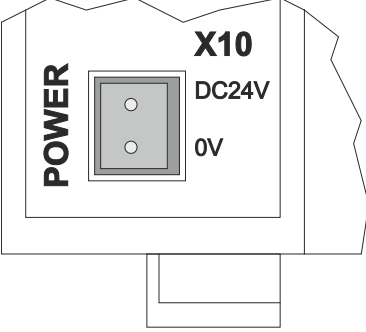
	Klemmpunkt	Beschreibung
	X10.DC24V	Versorgungsspannung für Steuerung JC-360 und angeschlossene JX3-Peripheriemodule
	X10.0V	Bezugspotenzial

## Technische Daten X10

Spannungsbereich:	DC 24 V, -15 % ... +20 %
Leistungsaufnahme:	Max. 1,5 A x 24,0 V = 36 W

## Leiteranschluss X10

Technologie:	Zugfederanschluss
Schraubendreher:	SD 0,4 x 2,5 - DIN 5264-A
AWG:	16 ... 28
Eindrähtig:	H05(07) V-U 0,2 mm <sup>2</sup> ... 1,5 mm <sup>2</sup>
Feindrähtig:	H05(07) V-K 0,2 mm <sup>2</sup> ... 1,5 mm <sup>2</sup>
Mit Aderendhülse:	0,2 mm <sup>2</sup> ... 1,5 mm <sup>2</sup>
Aderendhülse mit Kragen:	0,2 mm <sup>2</sup> ... 1,0 mm <sup>2</sup>

## Anschlussbeschreibung X11

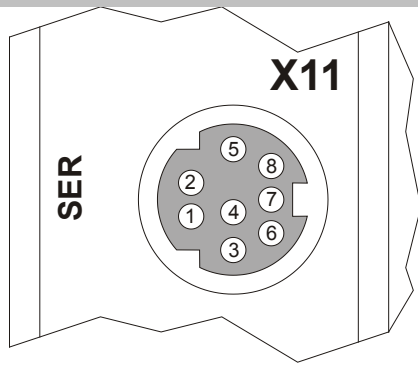

Pin	Signal	Beschreibung
1	RDA	RS-422, Rx invertiert
2	GND	Bezugspotenzial
3	RDB	RS-422, Rx nicht invertiert
4	RxD	RS-232; Rx
5	SDB	RS-422, Tx nicht invertiert
		RS-485, Rx/Tx nicht invertiert
6	DC24V	Versorgungsspannung Bediengerät
7	SDA	RS-422, Tx invertiert
		RS-485, Rx/Tx invertiert
8	TxD	RS-232; Tx

## Technische Daten X11

Steckertyp:

MiniDIN, 8-polig, geschirmt

Spannung für Bediengerät  
an X11.6:

Entspricht der Spannung an  
X10.DC24V

Strom für Bediengerät  
an X11.6:

Max. 0,5 A



## Anschlussbeschreibung X19

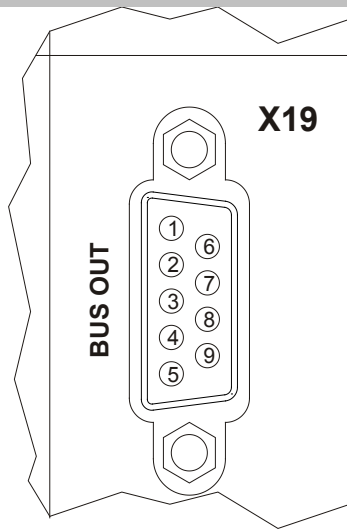

Pin	Signal
1	CMODE0
2	CL
3	GND
4	CMODE1
5	Unbenutzt
6	Unbenutzt
7	CH
8	Unbenutzt
9	Unbenutzt

## Technische Daten X19

Steckertyp:

Sub-D 9-polig, Buchse

## Hinweise zur EMV

- ✓ Beachten Sie die Application Note 016 *EMV-gerechte Schaltschrankinstallation*, die die Jetter AG erstellt hat.  
**Hinweis**  
Die Application Note 016 finden Sie im Downloadbereich auf unserer **Homepage** <http://www.jetter.de>.
- ✓ Weitere Informationen entnehmen Sie der Betriebsanleitung zur JC-360.

## Anschlussbeschreibung X14/X15

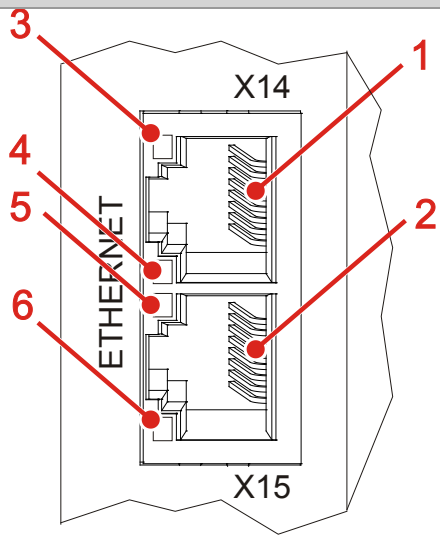

Nummer	Beschreibung
1	Buchse X14, Ethernet-Port
2	Buchse X15, Ethernet-Port
3	LED LINK: X14 mit einem Ethernet verbunden
4	LED ACT: JC-360 sendet oder empfängt über X14
5	LED LINK: X15 mit einem Ethernet verbunden
6	LED ACT: JC-360 sendet oder empfängt über X15

## Technische Daten X14/X15

Übertragungsrate:	10 MBit/s, 100 MBit/s
Auto-crossover:	Ja
Klemmenart:	RJ45-Buchse
Leitungsart:	Cat 5e, geschirmt

## SD-Karte stecken Steckplatz X61

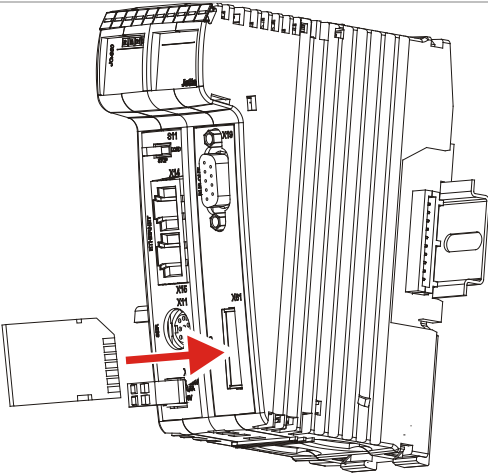
Schritt	Beschreibung	
1		<p>Stecken Sie die SD-Karte in der Position wie in der Abbildung beschrieben in den Steckplatz.</p> <p>Die Art und Weise, wie die SD-Karte gesteckt wird, ist dieselbe wie bei handelsüblichen Digitalkameras.</p>
⇒	<p>Wenn die SD-Karte richtig gesteckt ist, leuchtet die Status-LED <b>SD</b> der Steuerung für etwa 300 ms gelb auf.</p>	

## SD-Karte entfernen Steckplatz X61

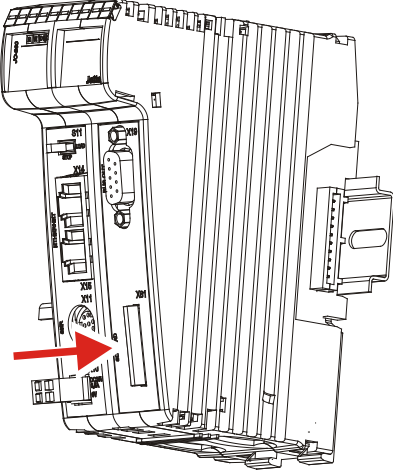
Schritt	Beschreibung
1	Greifen Sie nicht auf die SD-Karte zu, während Sie die SD-Karte entfernen. Schließen Sie davor alle Dateien, die auf der SD-Karte gespeichert sind.
2	 Durch Drücken und wieder Loslassen der SD-Karte löst sich diese aus der Arretierung und kann entfernt werden.
⇒	Wenn Sie die SD-Karte entfernt haben, leuchtet die Status-LED <b>SD</b> der Steuerung zweimal für 100 ms auf.

## Technische Daten X61

Kartentyp:	SD-Karte, SDHC-Karte
Mechanismus:	push-push
Speicherplatz:	8 MByte ... 4 GByte
Formatierung:	FAT/FAT 32
Verdrehgeschützt:	Ja

### Jetter AG

Graeterstrasse 2  
D-71642 Ludwigsburg  
Germany

### Communication:

E-mail - Sales: sales@jetter.de  
E-mail - Hotline: hotline@jetter.de  
Phone - Hotline: +49(0)7141/2550-444

## Installation Manual

Item # 60873051 | Revision 1.50

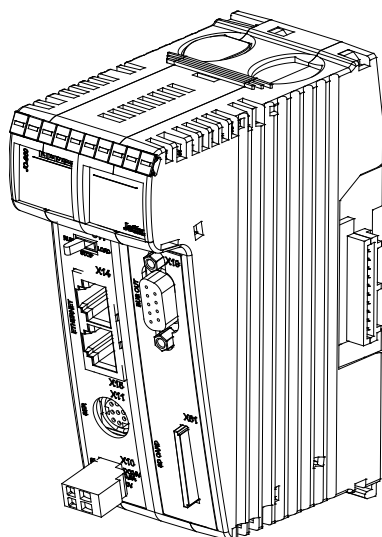

December 2016 / Printed in Germany

Download the user manual from  
[www.jetter.de](http://www.jetter.de), Downloads.

### Scope of delivery

1 x	JC-360	Options: [MC]-[A]-[R]
1 x	60870409	2-pin connector, spring-cage connection
10 x	60870411	Terminal labels
1 x	60873051	Installation Manual

## Installation on DIN rail to EN 50022

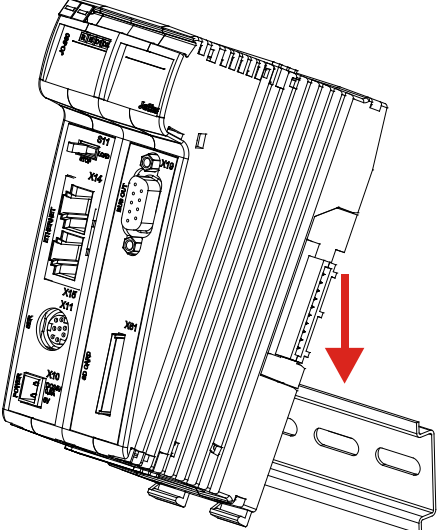
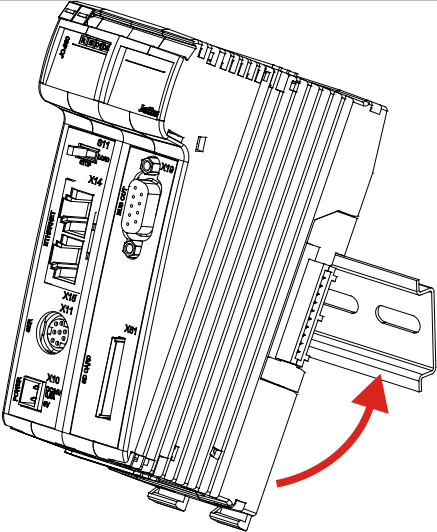
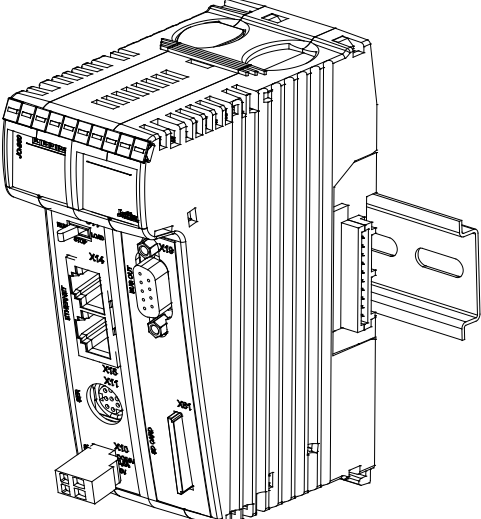
Step	Action
1	 <p>Place the JC-360 on the upper edge of the DIN rail.</p>
2	 <p>Move the JC-360 in the direction of the arrow until it snaps into place.</p>
3	 <p>Installation of the JC-360 to the DIN rail is now completed.</p>

## Setting the IP address

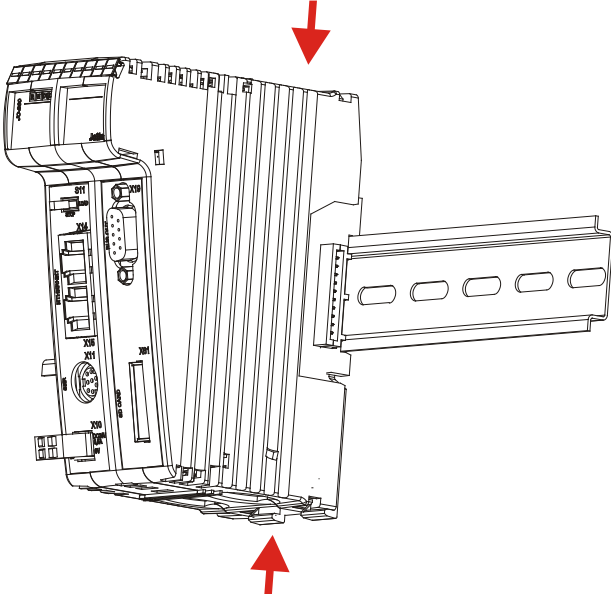
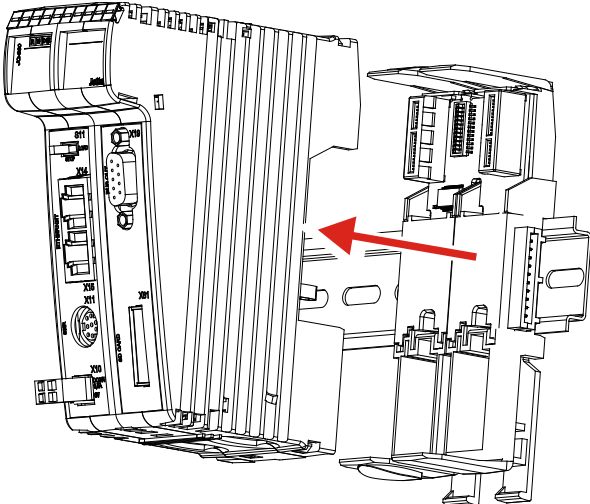
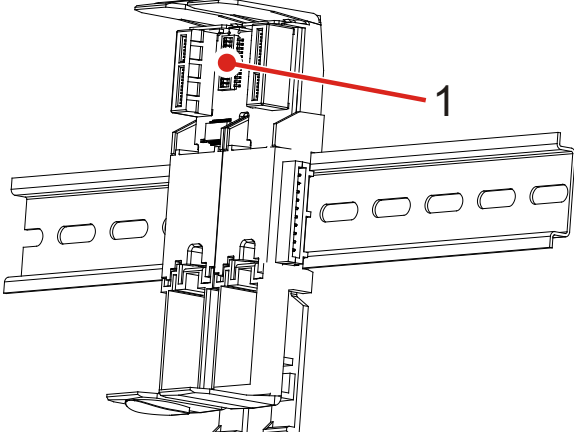
Step	Action
1	Remove power from the JC-360 and all JX3 modules connected to the JX3 station.
2	 <p>Press the upper and lower latches.</p>
3	 <p>Pull off the JX3 enclosure.</p>
4	 <p>Now, the DIP switches (1) on the JX3 backplane module can be accessed.</p>

## Setting the IP address

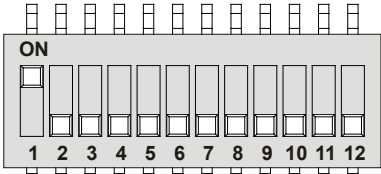
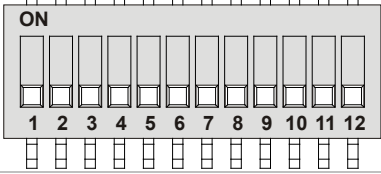
Step	Action
<b>5</b>	<p>Set the IP address using the DIP switches (1).</p> <p style="text-align: center;">IP address: 192.168.1.1 Factory settings</p>  <p style="text-align: center;">IP address: 192.168.10.15 Default IP address</p> 
<b>6</b>	Reattach the JX3 enclosure to the JX3 backplane module.
<b>7</b>	Restore the power supply of the JX3 station.

For further information on setting the IP address, please refer to the user manual of the device.



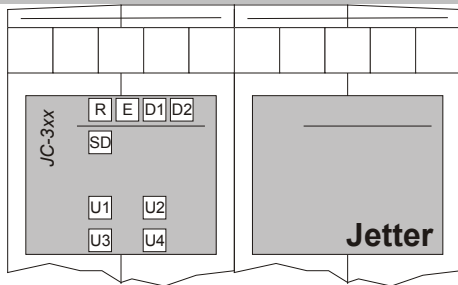





















## LEDs



LED	Color	Description
R	Green	OS is running
E	Red	Generic error
D1	Red	Special conditions
D2	Red	Boot loader is running
SD	Amber	Access to SD card
U1 ... U4	Amber	Programmable depending on the application



## LED states at power-up

Step	R	E	D1	D2	Description
<b>1</b>	 4Hz	 4Hz	 4Hz	 4Hz	Reset
<b>2</b>	 1Hz	 OFF	 OFF	 ON	Boot loader is running and is checking the OS.
<b>3</b>	 1Hz	 OFF	 OFF	 OFF	The OS reads the settings of the DIP switch on the JX3 backplane module and checks if an Ethernet switch exists.
<b>4</b>	 1Hz	 ON	 OFF	 OFF	The OS initializes realtime clock, Ethernet interface and file system.
<b>5</b>	 1Hz	 ON	 ON	 OFF	The OS initializes the modules on the JX3 and JX2 system bus, as well as software features (Web, Modbus/TCP, etc.); then it loads the application program.
<b>6</b>	 ON	 OFF	 OFF	 OFF	Normal operating condition

## Mode selector S11

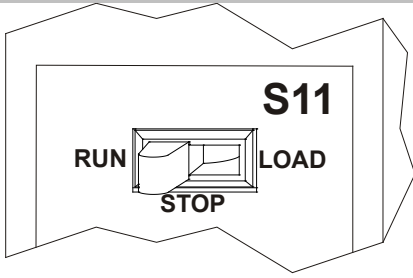

### Position

### Description

RUN

Once the JC-360 is turned on, it launches the application program.

STOP

When the JC-360 is turned on, the application program will not be launched.

LOAD

Once the JC-360 is turned on, it executes the file **autocopy.ini** which is located on the SD card. If there has no SD card been supplied, the boot loader does not start up the operating system.

## Terminal X10 - Description

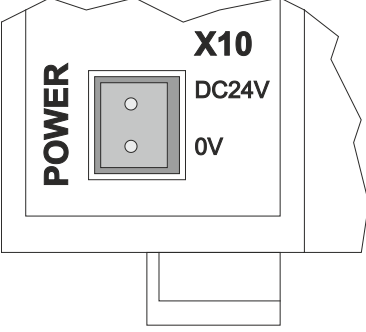
	Terminal point	Description
	X10.DC24V	Power supply for the JC-360 and connected JX3 peripheral modules
	X10.0V	Reference potential

## X10 - Technical data

Input voltage range:	DC 24 V -15 % ... +20 %
Power consumption:	1.5 A x 24.0 V = 36 W max.

## X10 - Wiring

Technology:	Spring-cage connection
Screwdriver:	SD 0.4 x 2.5 - DIN 5264-A
AWG:	16 ... 28
Solid conductor:	H05(07) V-U 0.2 mm <sup>2</sup> ... 1.5 mm <sup>2</sup>
Flexible conductor:	H05(07) V-K 0.2 mm <sup>2</sup> ... 1.5 mm <sup>2</sup>
With wire end ferrule:	0.2 mm <sup>2</sup> ... 1.5 mm <sup>2</sup>
Wire end ferrule with sleeve:	0.2 mm <sup>2</sup> ... 1.0 mm <sup>2</sup>

## Connector X11 - Description

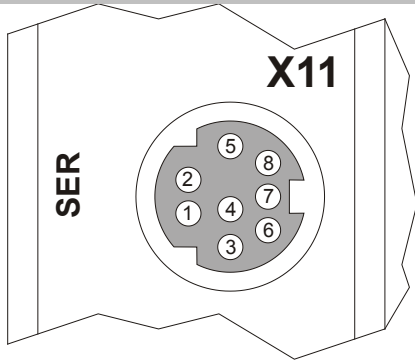

Pin	Signal	Description
1	RDA	RS-422, Rx inverted
2	GND	Reference potential
3	RDB	RS-422, Rx not inverted
4	RxD	RS-232; Rx
5	SDB	RS-422, Tx not inverted
		RS-485, Rx/Tx not inverted
6	DC 24 V	HMI supply voltage
7	SDA	RS-422, Tx inverted
		RS-485, Rx/Tx inverted
8	TxD	RS-232; Tx

## X11 - Technical data

Connector type: MiniDIN, 8-pin, shielded

Voltage for the HMI at X11.6: It corresponds to the voltage at X10.DC24V

Current for the HMI at X11.6: 0.5 A max.

## Connector X19 - Description

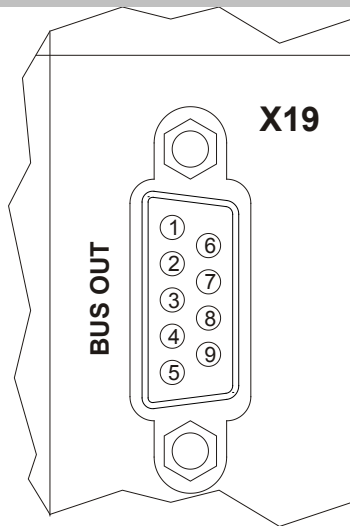

Pin	Signal
1	CMODE0
2	CL
3	GND
4	CMODE1
5	Unused
6	Unused
7	CH
8	Unused
9	Unused

## X19 - Technical data

Connector type: 9-pin female SUB-D connector

## Instructions on EMI

- ✓ Also refer to Application Note 016 *EMC-compatible installation of electric cabinets* by Jetter AG.

### Note

For downloading the Application Note 016, please turn to our **homepage** <http://www.jetter.de>, **Downloads**.

- ✓ For further information please refer to the JC-360 user manual.

## Connectors X14/X15 - Description

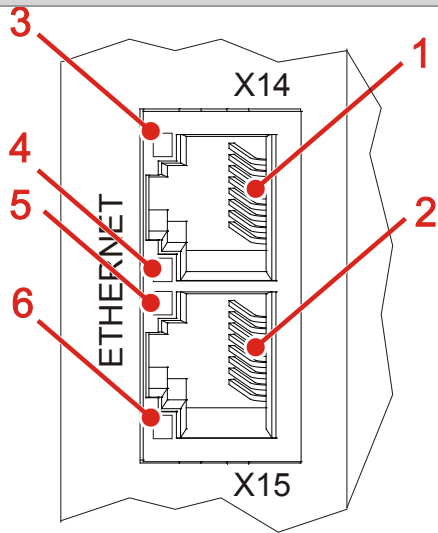

Number	Description
1	Female connector X14, Ethernet port
2	Female connector X15, Ethernet port
3	LED LINK: X14 is connected with Ethernet
4	LED ACT: JC-360 is transmitting or receiving signals via X14
5	LED LINK: X15 is connected with Ethernet
6	LED ACT: JC-360 is transmitting or receiving signals via X15

## X14/X15 - Technical data

Bit rate:	10 MBit/s, 100 MBit/s
Auto-crossover:	Yes
Terminal type:	RJ45 Ethernet port
Cable category:	Cat 5e, shielded

## Insert the SD card into slot X61

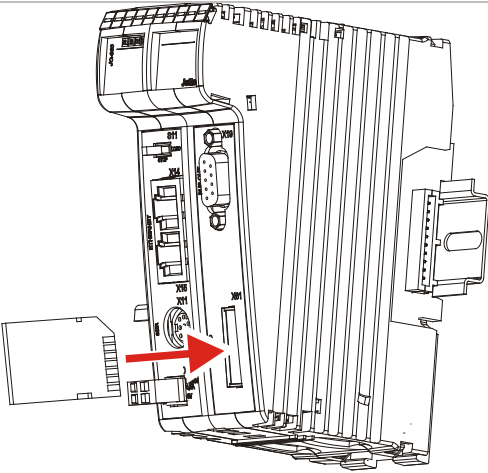
Step	Description
1	 <p data-bbox="922 259 1461 734">Insert the SD card into the SD slot as illustrated. The way of inserting the SD card correctly is the same as in common digital cameras.</p>
⇒	<p data-bbox="309 763 1401 925">If the SD card has been inserted correctly, the status LED <b>SD</b> of the controller lights up for approximately 300 ms.</p>

## Remove the SD card from slot X61

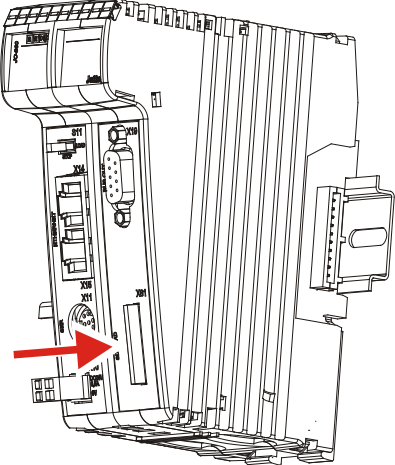
Step	Description
1	Make sure the SD card is not accessed, while you are removing it. First, close all files which are stored to the SD card.
2	 <p data-bbox="922 524 1453 943">To remove the SD card, press it further into the slot and let go again to release the lock. Now the SD card can be taken out.</p>
⇒	After removing the SD card, the status LED <b>SD</b> of the controller lights up twice for 100 ms each time.

## X61 - Technical data

Board type:	SD card, SDHC card
Mechanical operation:	push/push
Memory:	8 MByte ... 4 GByte
Card format:	FAT/FAT 32
Protection against wrong card orientation:	Yes